

Photos of the Units

Ball Screw Drive, Ball Guide 1  2  3 	Belt Drive, Ball Guide 6  7  8  9 	Linear Lifting Units 14  15  16 
Ball Screw Drive, Slide Guide 4  5 	Belt Drive, Slide Guide 10  11 	Linear Rod Units 17  18  19 
	Belt Drive, Wheel Guide 12  13 	

Definition of Forces

Please use these definitions when referring to a force that are applied to the unit.

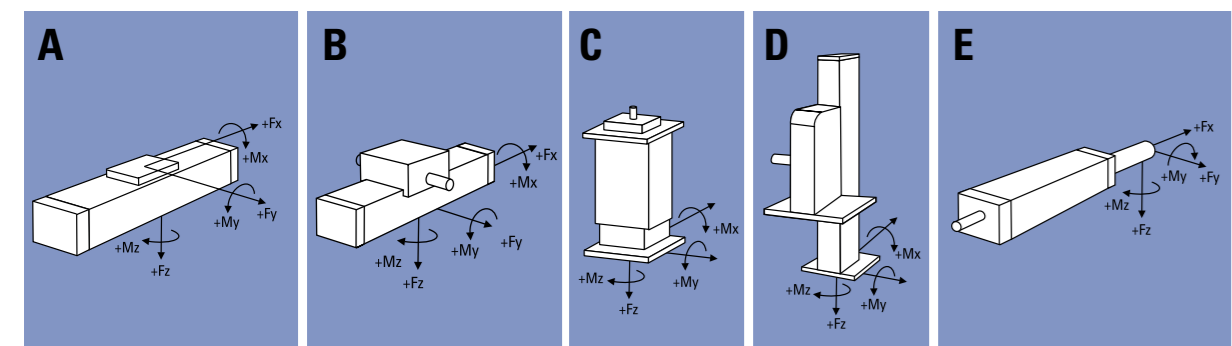

EUROPE

United Kingdom
 Danaher Motion
 Chartmoor Road, Chartwell Business Park
 Leighton Buzzard, Bedfordshire
 LU7 4WG, United Kingdom
 Phone: +44 (0)1525 243 243
 Fax: +44 (0)1525 243 244
 E-mail: sales.uk@danahermotion.com

Germany
 Danaher Motion GmbH
 Sales Office North
 Wacholderstr. 40-42
 40489 Düsseldorf
 Germany
 Phone: +49 (0) 203 9979 214
 Fax: +49 (0) 203 9979 3214
 E-Mail: iris.tolusch@danahermotion.com

Danaher Motion GmbH
 Sales Office South West
 Brückenfeldstraße 26/1
 75015 Bretten
 Germany
 Phone: +49 (0) 7252 97390 56
 Fax: +49 (0) 7252 97390 55
 E-Mail: kerstin.mueller@danahermotion.com

Danaher Motion GmbH
 Sales Office South East
 Kiesgräble 7
 89129 Langenau
 Germany
 Phone: +49 (0) 7471 62 23 23
 Fax: +49 (0) 7471 62 23 26
 E-Mail: ursula.koschak@danahermotion.com

France
 Danaher Motion
 C.P 80018
 12, Rue Antoine Becquerel – Z.I. Sud
 F-72026 Le Mans Cedex 2
 France
 Phone: +33 (0) 243 50 03 30
 Fax: +33 (0) 243 50 03 39
 E-mail: sales.france@tollo.com

Italy
 Danaher Motion srl
 Largo Brughetti
 I-20030 Bovisio Masciago
 Italy
 Phone: +39 0362 594260
 Fax: +39 0362 594263
 E-mail: info@danahermotion.it

Sweden

Danaher Motion
 Box 9053
 SE-291 09 Kristianstad
 Sweden
 Phone: +46 (0) 44-24 67 00
 Fax: +46 (0) 44-24 40 85
 E-mail: sales.scandinavia@danahermotion.com

Switzerland
 Danaher Motion SA
 La Pierreire 2
 1029 Villars-Ste-Croix
 Switzerland
 Phone: +41 (0) 21 631 33 33
 Fax: +41 (0) 21 636 05 09
 E-mail: info@danaher-motion.ch

USA, CANADA and MEXICO

Danaher Motion
 203A West Rock Road
 Radford, VA 24141 USA
 Phone: 1-540-633-3400
 Fax: 1-540-639-4162
 E-mail: DMAC@danahermotion.com
 Literature: LitRequest@danahermotion.com

ASIA

China
 Danaher Motion
 Rm 2205, Scitech Tower
 22 Jianguomen Wai Street
 Beijing, China, 100004
 Phone: +86 10 6515 0260
 Fax: +86 10 6515 0263
 E-mail: chinainfo@danahermotion.com.cn

Japan
 Danaher Motion Japan
 2F, Tokyu Reit Hatchobori Bldg
 2-7-1 Hatchobori Chuo-ku,
 Tokyo 104-0032 Japan
 Phone: +81-3-6222-1051
 Fax: +81-3-6222-1055
 E-mail: info@danahermotion.co.jp

DW110482GB-0623
 Information & specifications subject to change at any time. Printed in Sweden.
 © Danaher Motion GmbH 2006

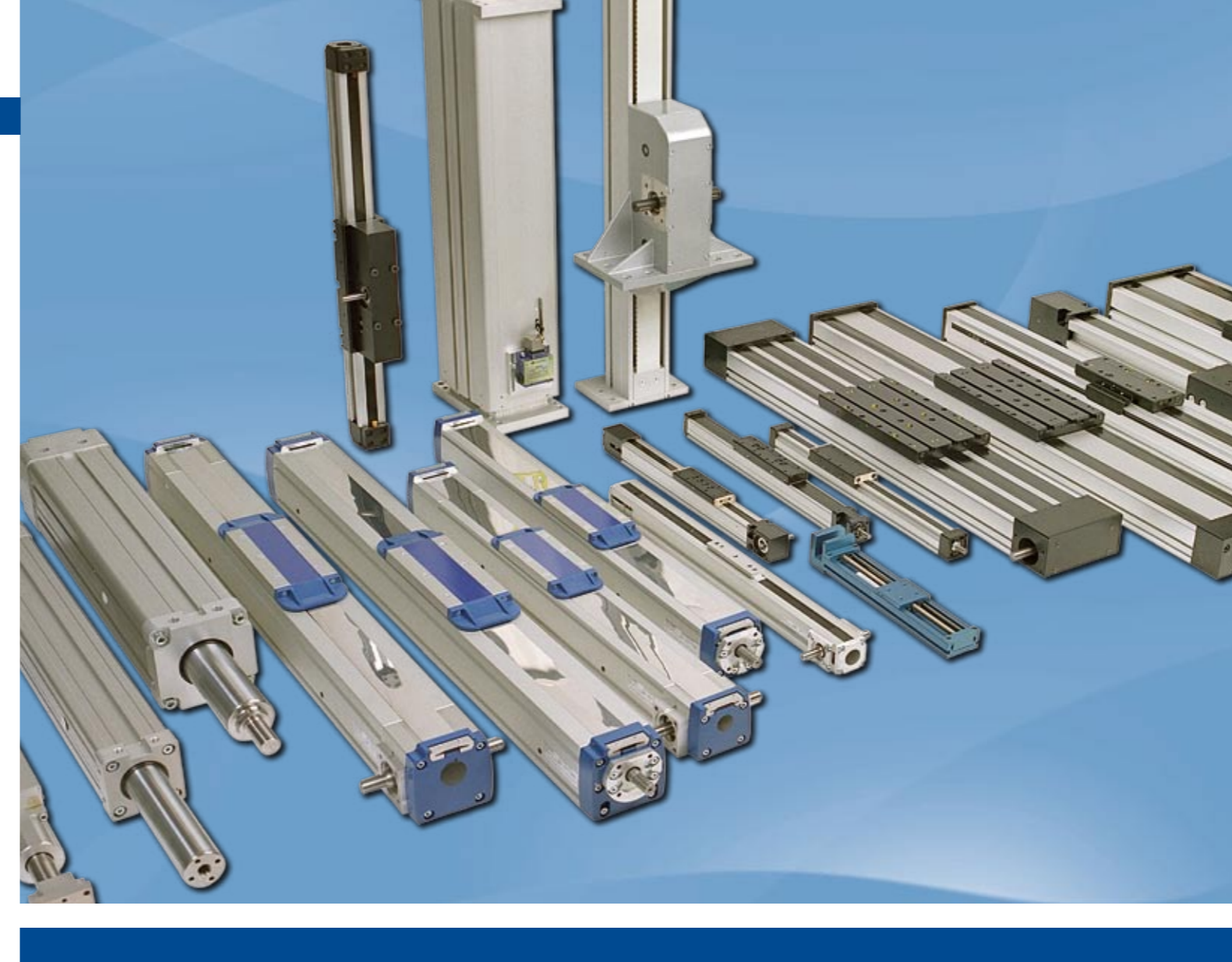

Linear Units Quick Selection Guide



Product Groups

Danaher Motions linear units are divided in to seven product groups depending of the drive and guiding method being used.

Ball screw driven - ball guided units

Units designed for high thrust, payload, precision and stiffness.

- Force up to 12000 N
- Repeatability down to 0,005mm

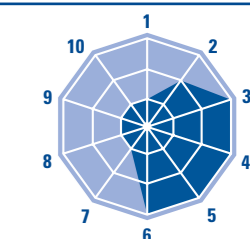

Ball screw driven - slide guided units

Low cost units for high thrust applications and demanding environments.

- Durable guide system
- Washdown protected version

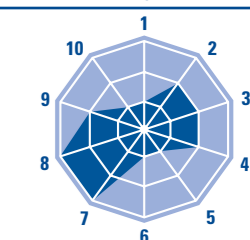

Belt driven - ball guided units

Smooth running units for high speed, acceleration and load requiring a long lifetime.

- Speed up to 5 m/s
- Acceleration up to 40 m/s²

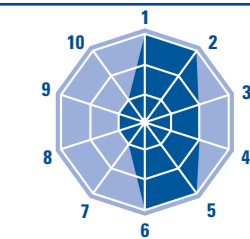

Belt driven - slide guided units

Units for applications requiring smooth travel, high speed, high acceleration and low maintenance.

- Cost efficient guide system
- Chemically protected versions

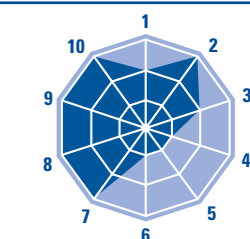

Belt driven - wheel guided units

Units for high speed, high acceleration, smooth motion and medium to high loads.

- Speed up to 10 m/s
- Acceleration up to 40 m/s²

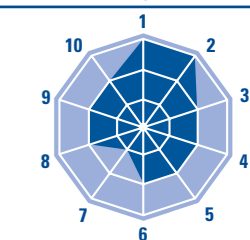

Linear lifting units

Units for lifting applications that often are used in X-Y configurations in combination with other linear units.

1. Velocity
2. Acceleration
3. Repeatability
4. Force
5. Load torque
6. Stiffness
7. Guide robustness
8. Cost
9. Maintenance
10. Noise

Linear rod units

Units designed for lifting applications or for the replacement of hydraulic and pneumatic cylinders.

